

WC5 CUTTING PATTERNS

DESIGNED BY: J. RANDLE

DESIGN DATE: 09/12/05



PROPRIETARY AND CONFIDENTIAL

The information contained in these drawings is the sole property of RANDLE DESIGN, LLC. Any reproduction in part or as a whole without the written permission of RANDLE DESIGN, LLC is prohibited.

The cutting patterns in this package are designed to print full scale from Adobe Acrobat Reader™ on a standard laser jet or ink jet printer. Page scaling should be set to "None"; "Auto-Rotate and Center" should be turned off; and the print quality should be set to 300 dpi.

It is recommended that all pattern sheets be printed on good quality adhesive backed paper to simplify attaching the patterns to the face of the stock to be cut.

To attach the patterns: cut them apart, remove the backing, and stick them to the face of the material to be cut. The pattern should remain in place until all drilling, sawing, and edge sanding is completed.

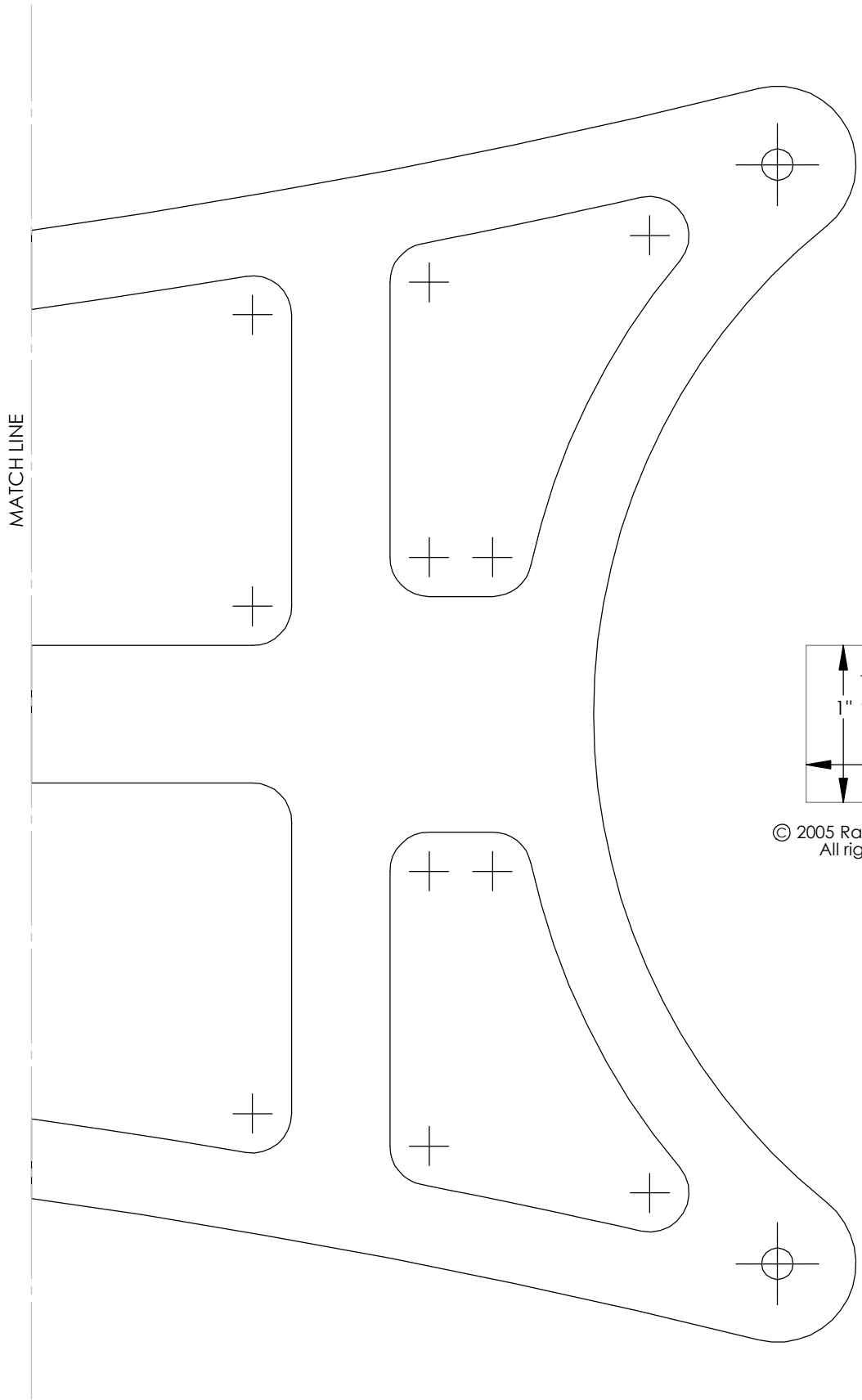

© 2005 Randle Design, LLC
All rights reserved

**CUTTING PATTERN
WC5-02-01 (BOTTOM SECTION)**

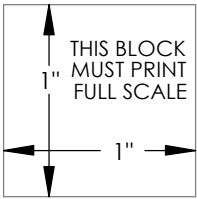

© 2005 Randle Design, LLC
All rights reserved

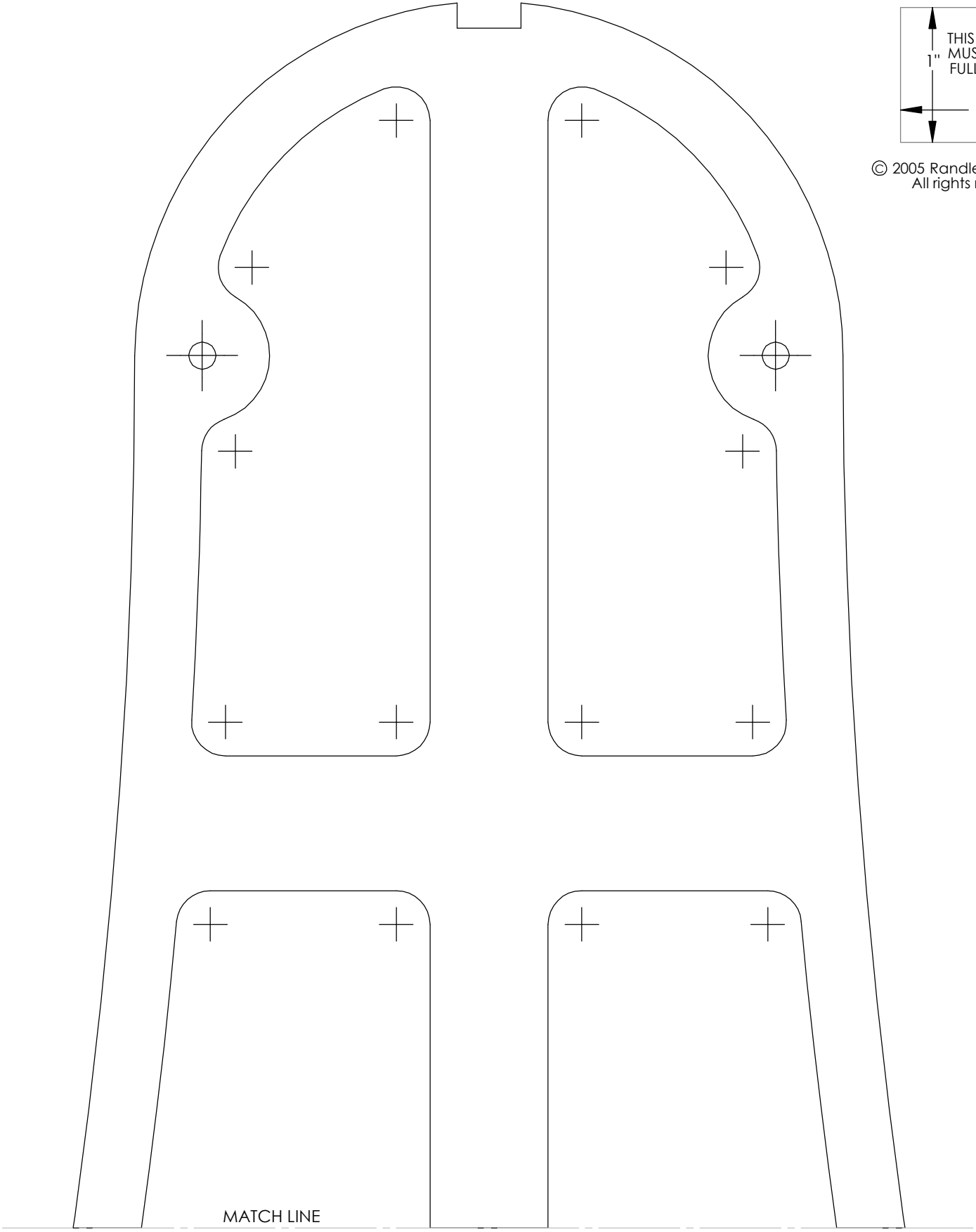

**CUTTING PATTERN
WC5-02-01 (TOP SECTION)**

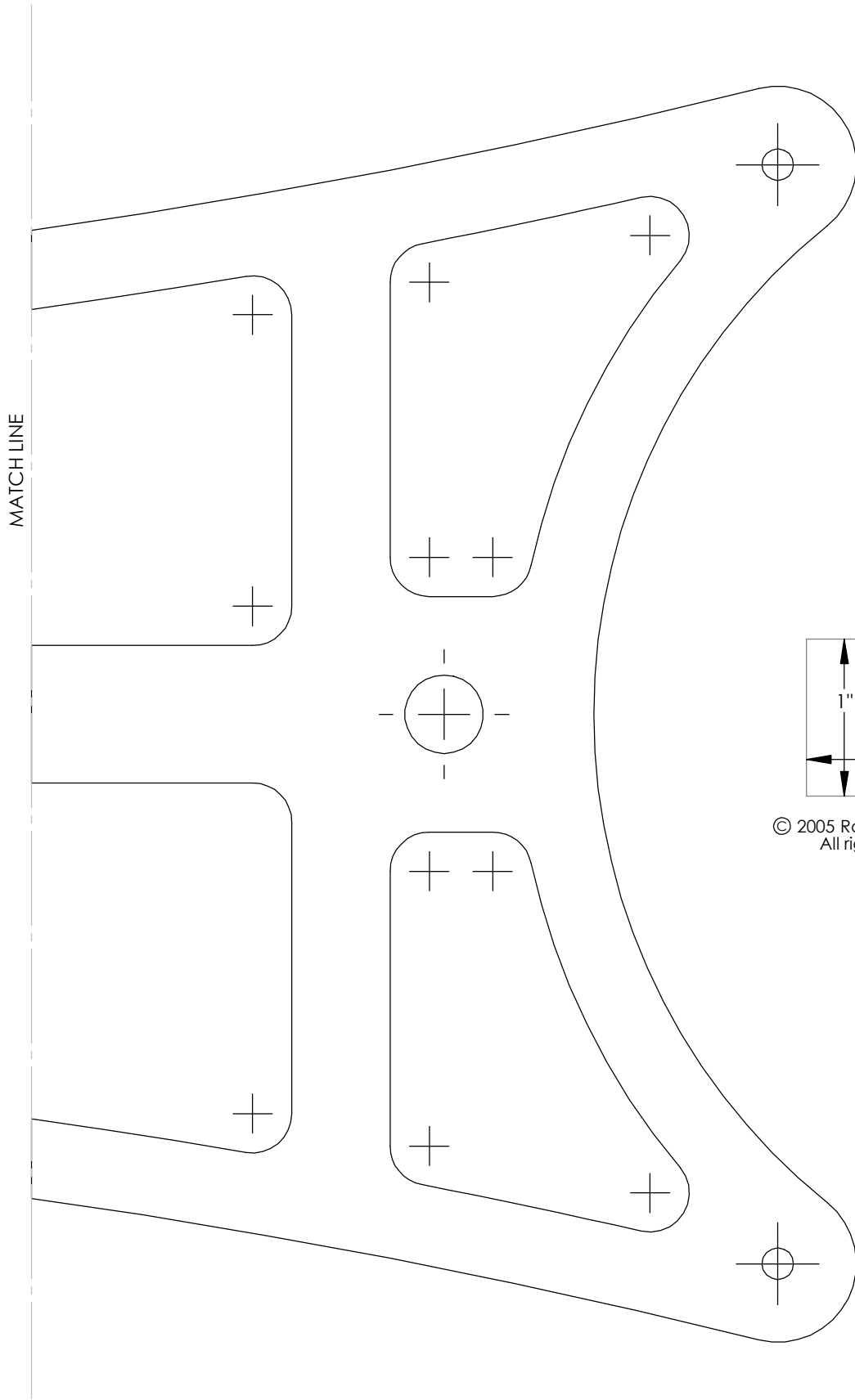

MATCH LINE

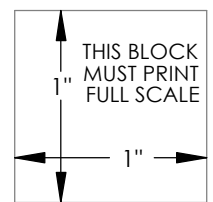

© 2005 Randle Design, LLC
All rights reserved

**CUTTING PATTERN
WC5-02-02 (BOTTOM SECTION)**

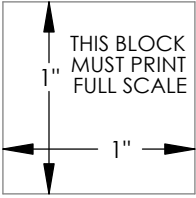

© 2005 Randle Design, LLC
All rights reserved

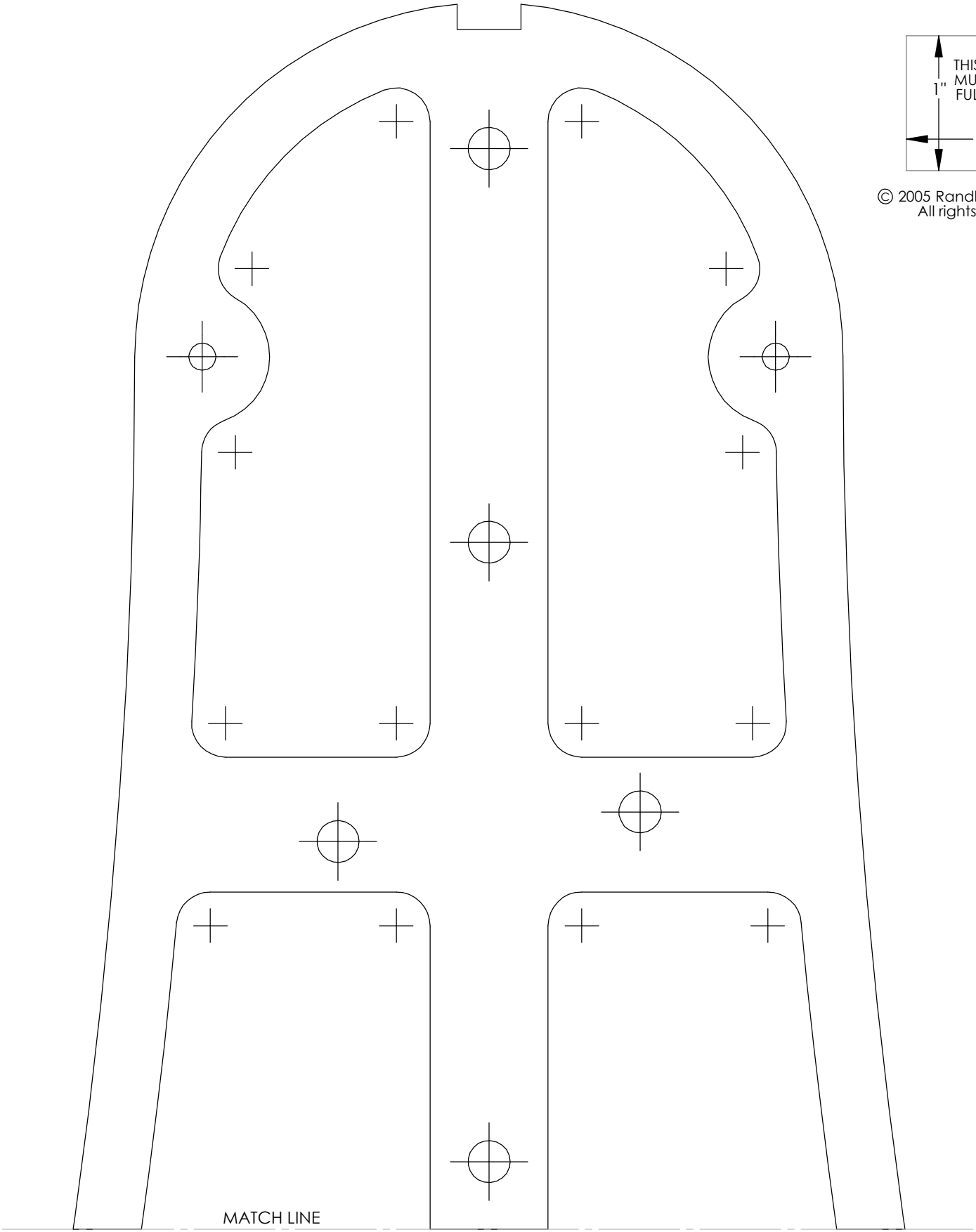

**CUTTING PATTERN
WC5-02-02 (TOP SECTION)**

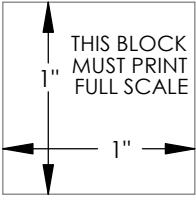
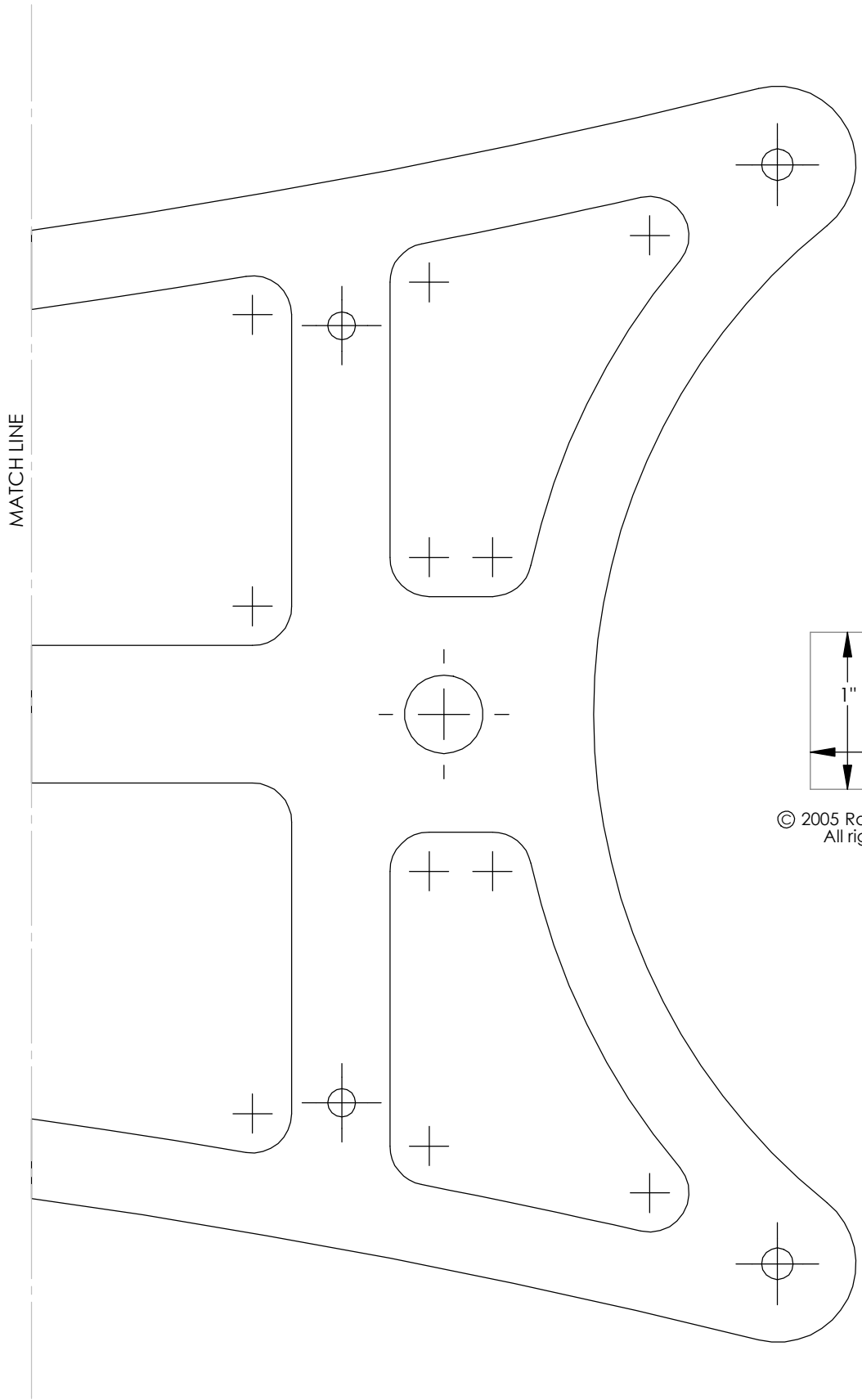

© 2005 Randle Design, LLC
All rights reserved

**CUTTING PATTERN
WC5-02-03 (BOTTOM SECTION)**

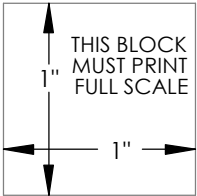

© 2005 Randle Design, LLC
All rights reserved

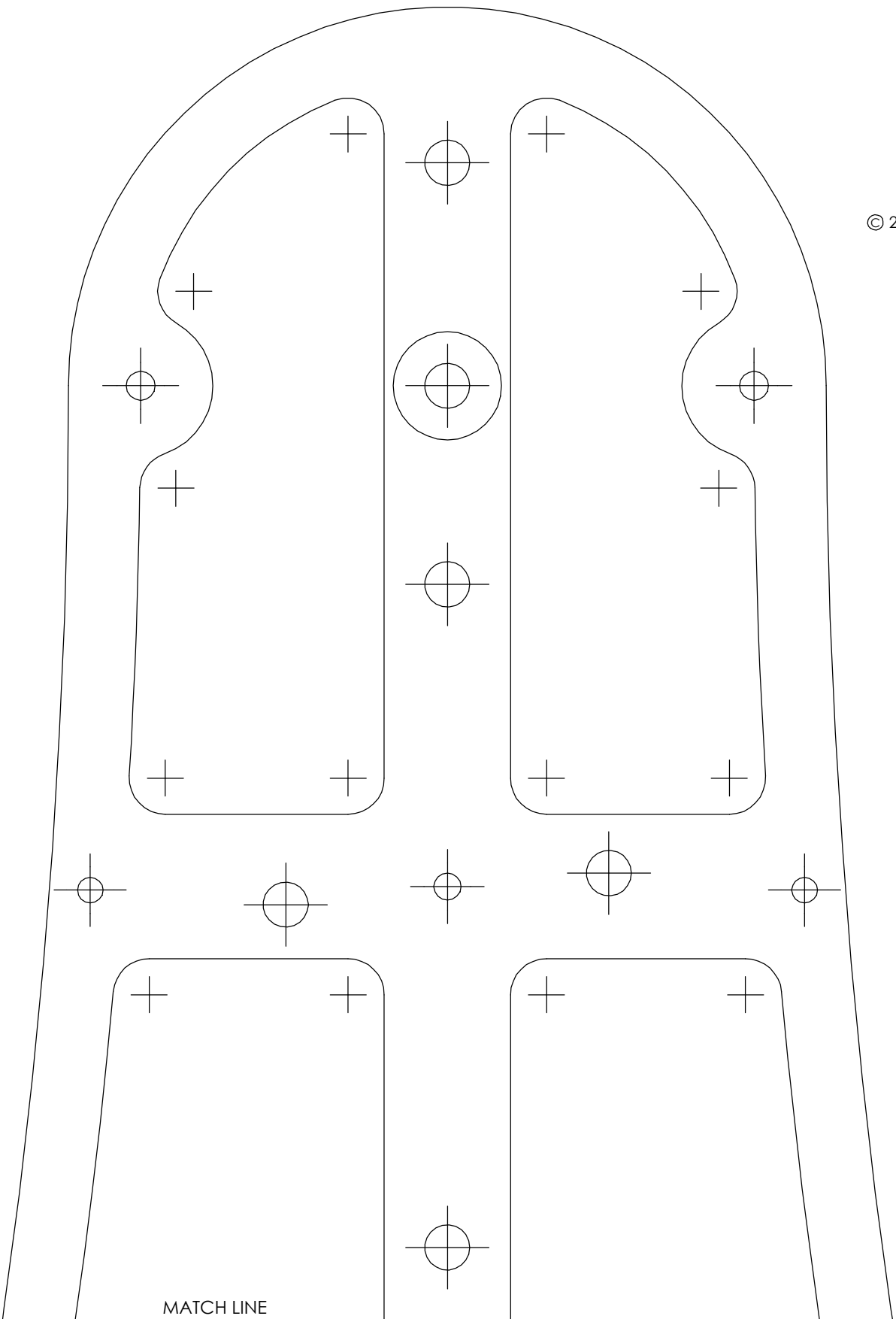

**CUTTING PATTERN
WC5-02-03 (TOP SECTION)**

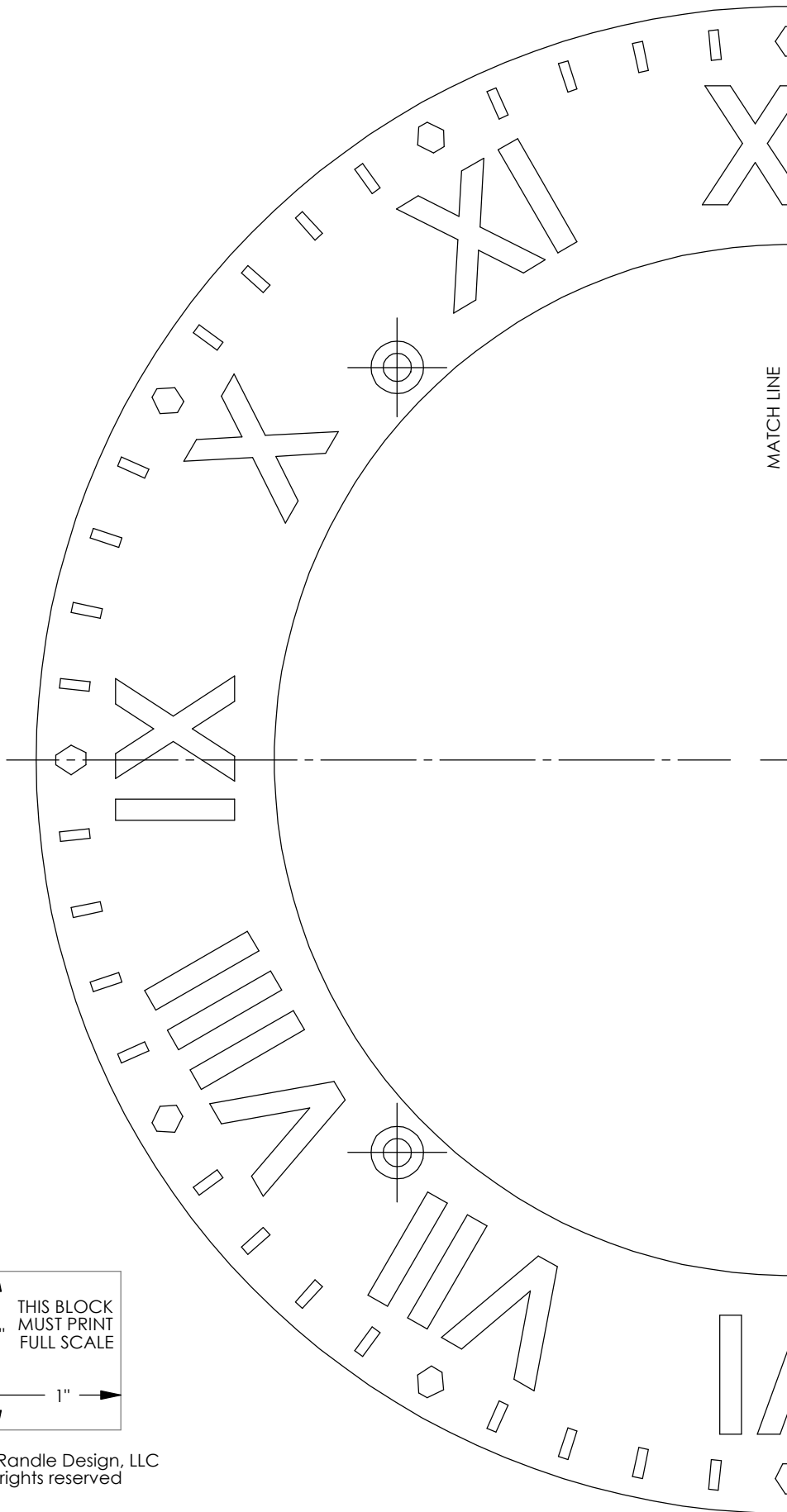

MATCH LINE

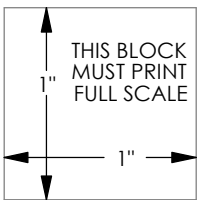

© 2005 Randle Design, LLC
All rights reserved

**CUTTING PATTERN
WC5-02-04 (LEFT HALF)**

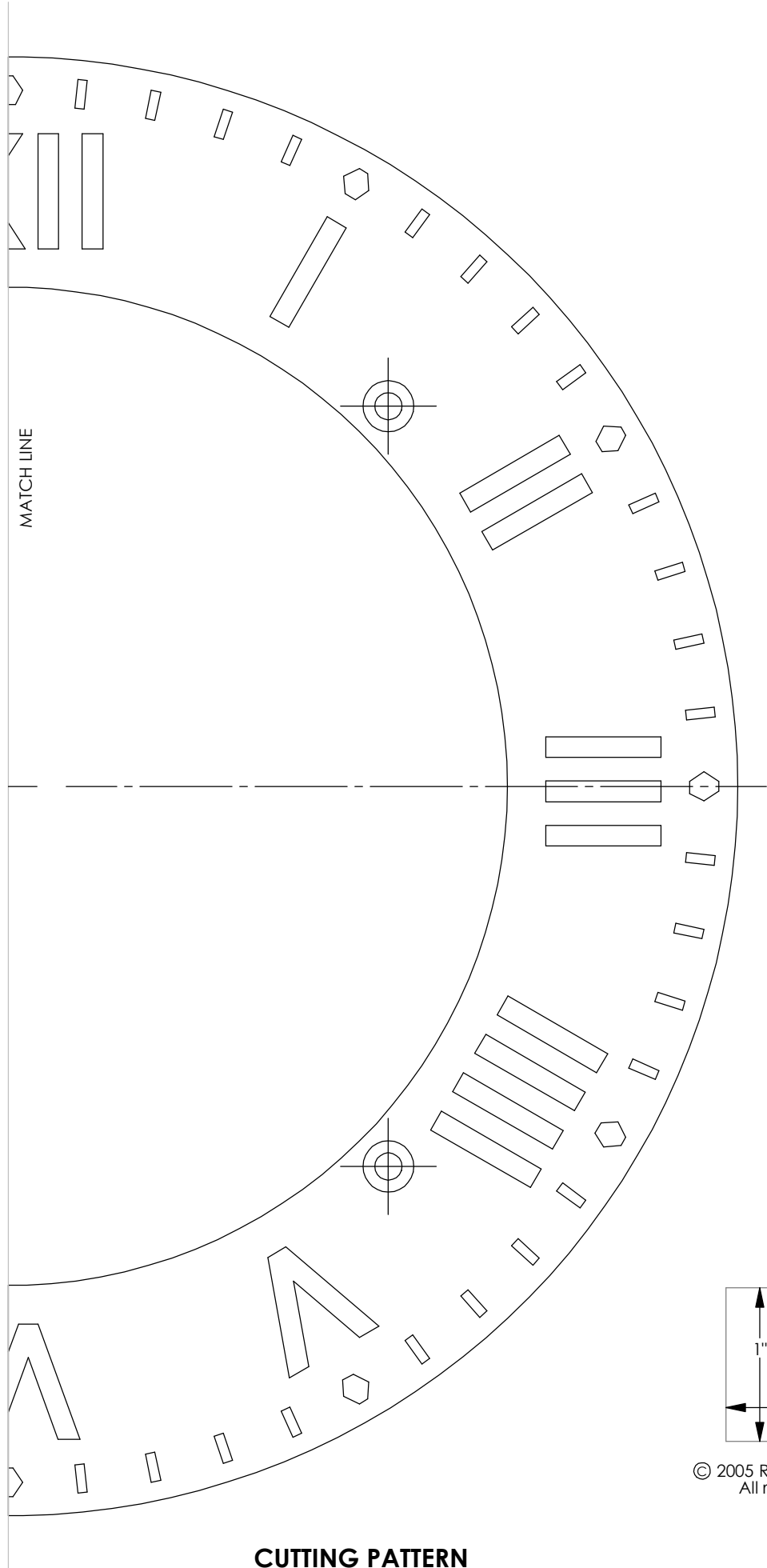

MATCH LINE

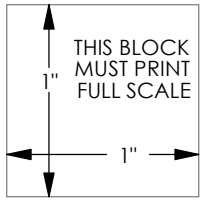

© 2005 Randle Design, LLC
All rights reserved

**CUTTING PATTERN
WC5-02-04 (RIGHT HALF)**

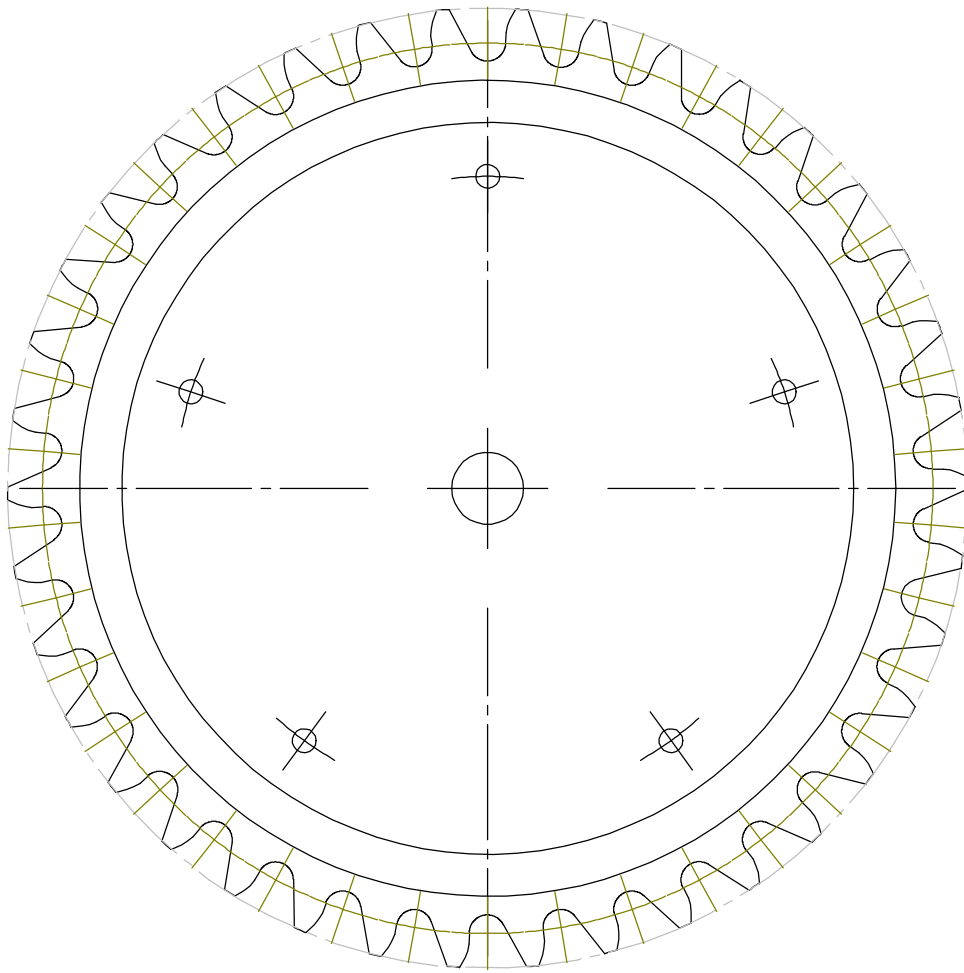

**CUTTING PATTERN
WC5-03-01**

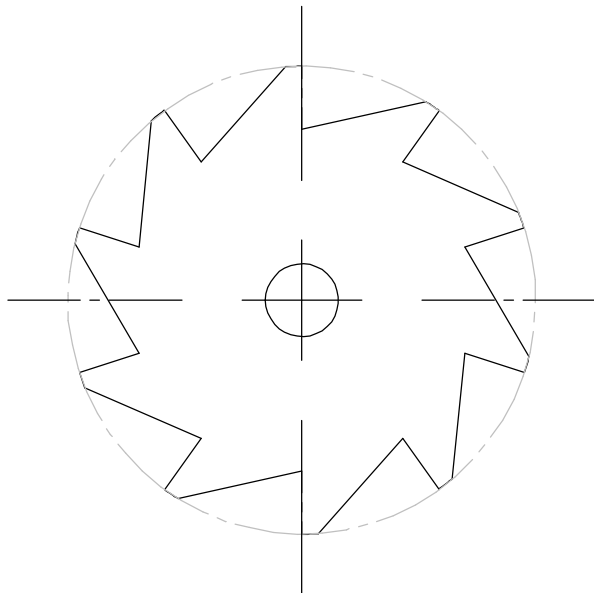

**CUTTING PATTERN
WC5-03-04**

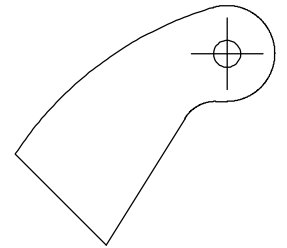
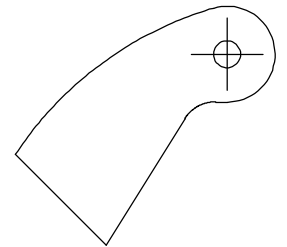
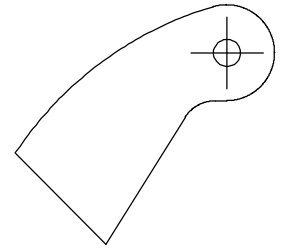
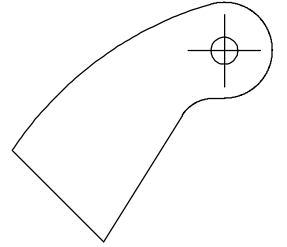
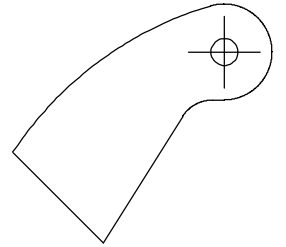

**CUTTING PATTERNS
WC5-03-03-01**

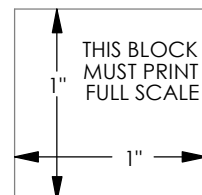

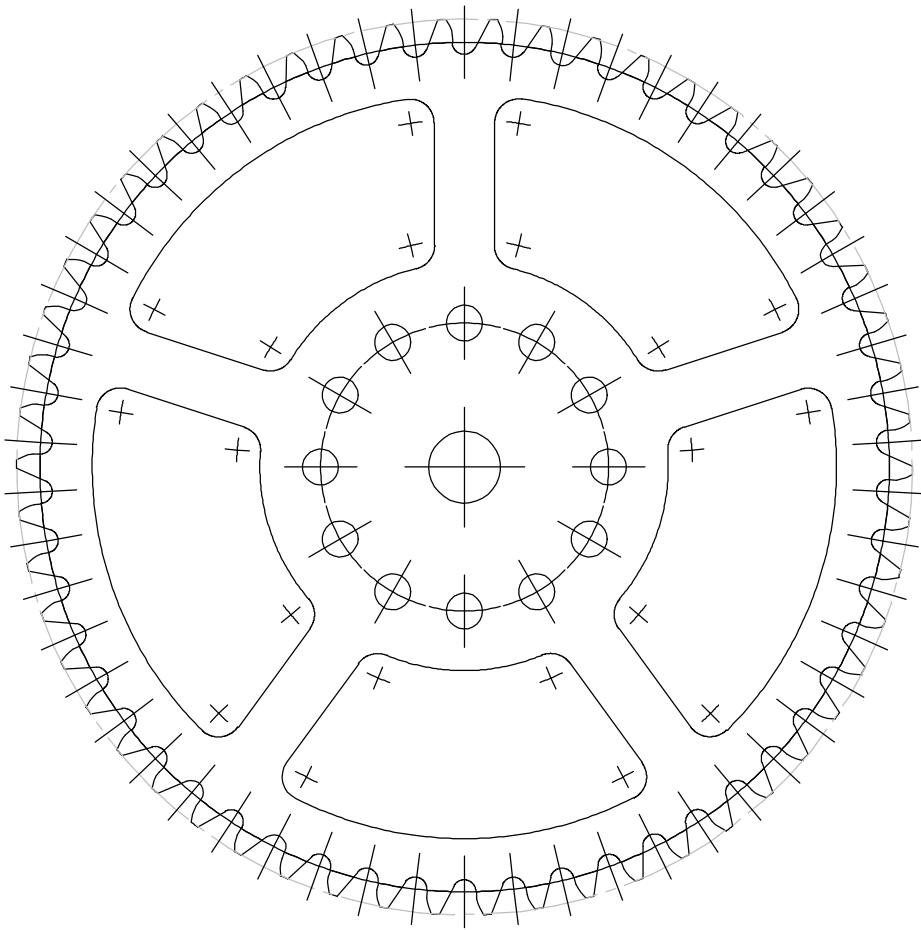

**CUTTING PATTERN
WC5-04-03**

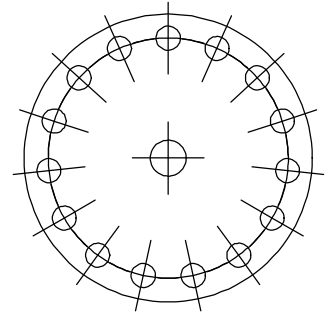

**CUTTING PATTERN
WC5-05-02**

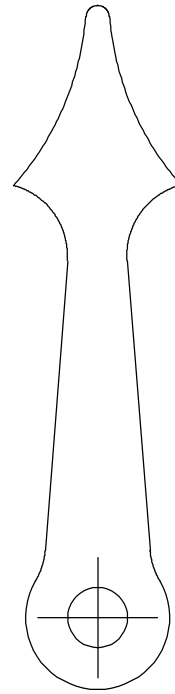

**CUTTING PATTERN
WC5-05-05**

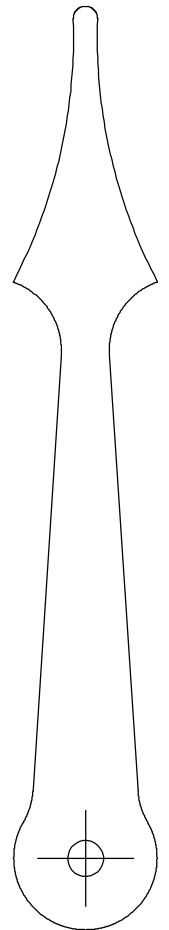

**CUTTING PATTERN
WC5-05-04**

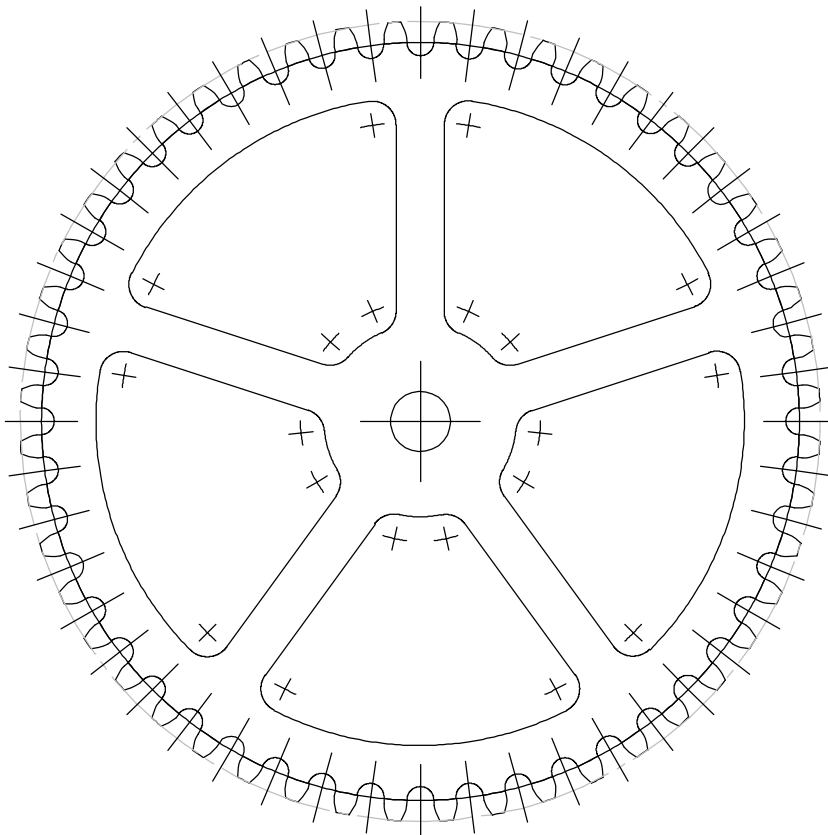

**CUTTING PATTERN
WC5-05-03**

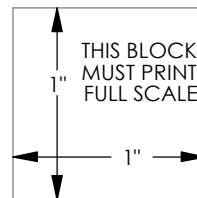

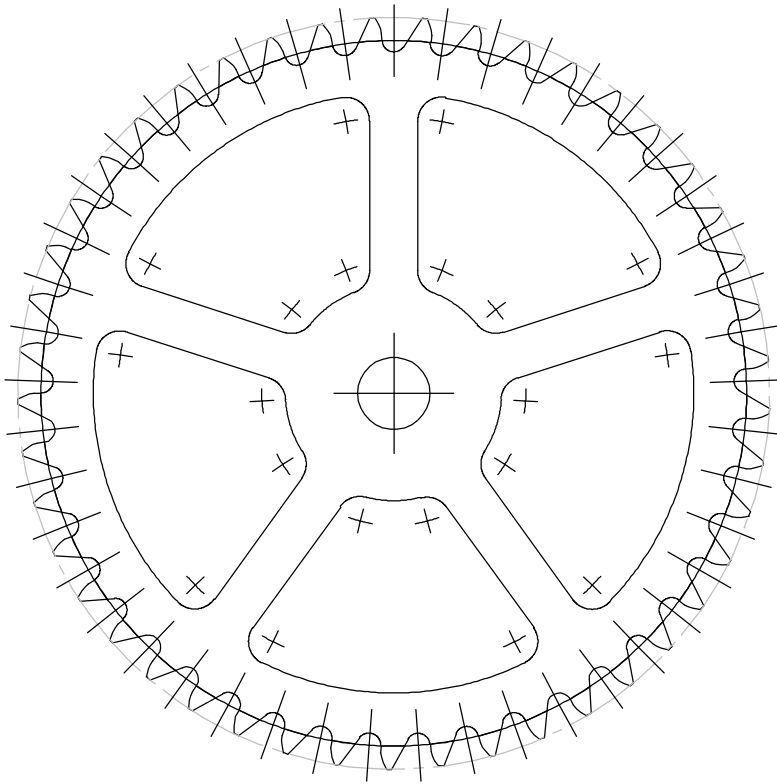

**CUTTING PATTERN
WC5-06-02**

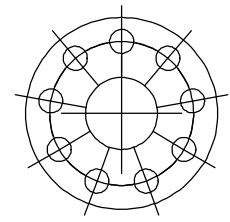

**CUTTING PATTERN
WC5-06-01**

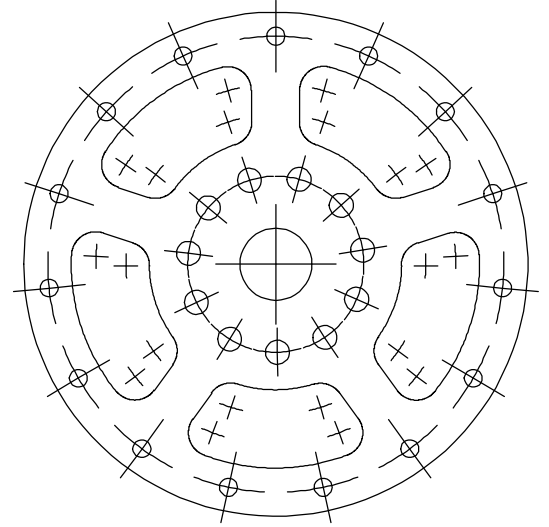

**CUTTING PATTERN
WC5-08-01**

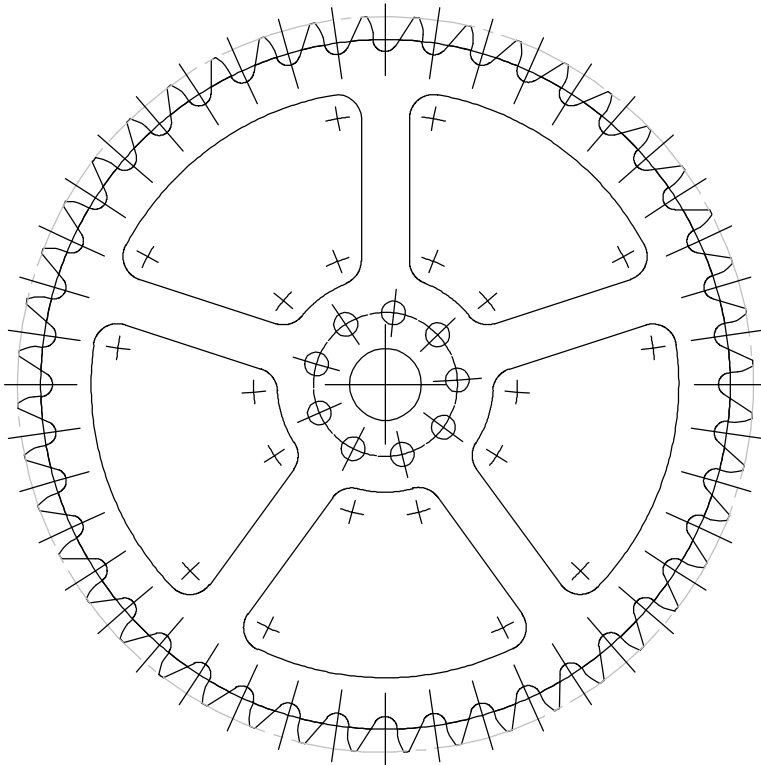

**CUTTING PATTERN
WC5-07-01**

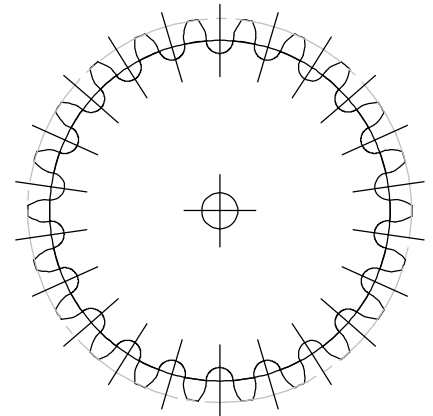

**CUTTING PATTERN
WC5-09-02**

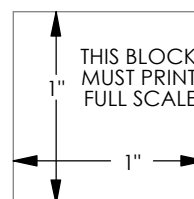

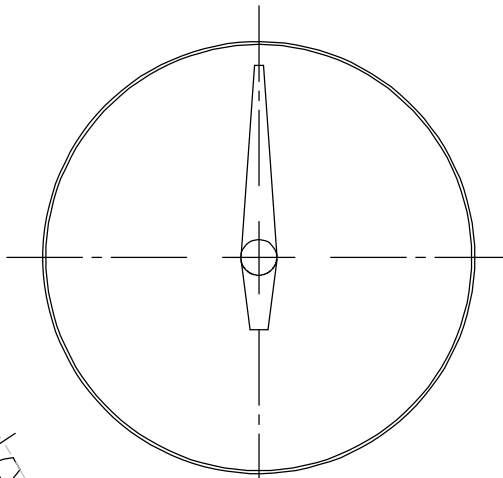

**CUTTING PATTERN
WC5-09-03**

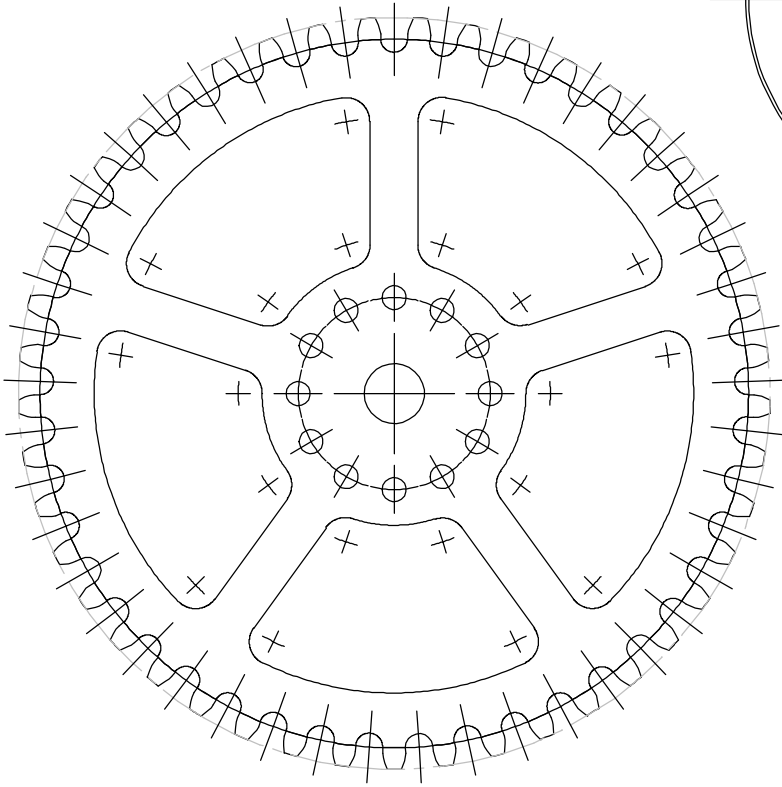

**CUTTING PATTERN
WC5-10-02**

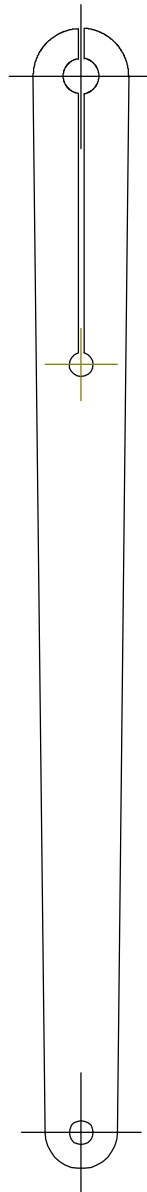

**CUTTING PATTERN
WC5-11-02**

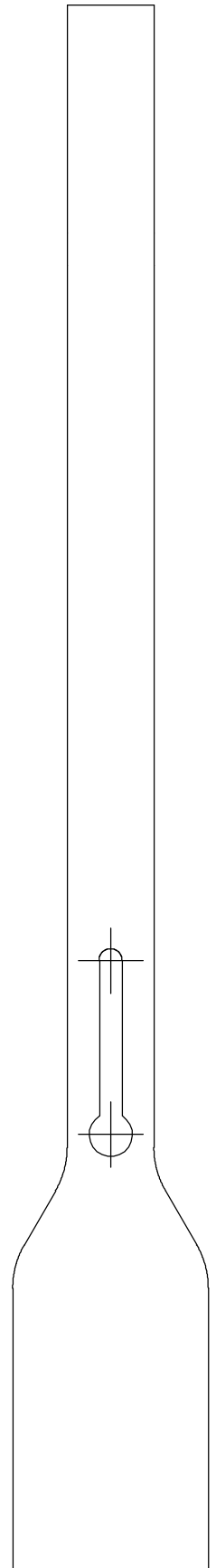

**CUTTING PATTERN
WC5-12-01**

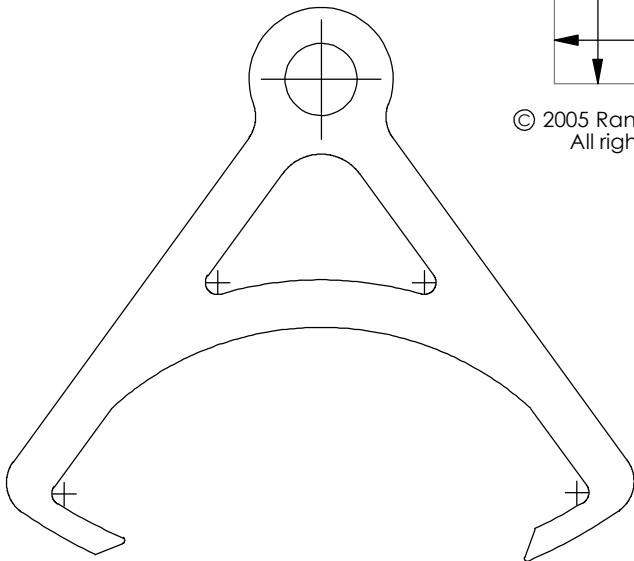

**CUTTING PATTERN
WC5-11-01**

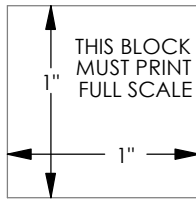

© 2005 Randle Design, LLC
All rights reserved

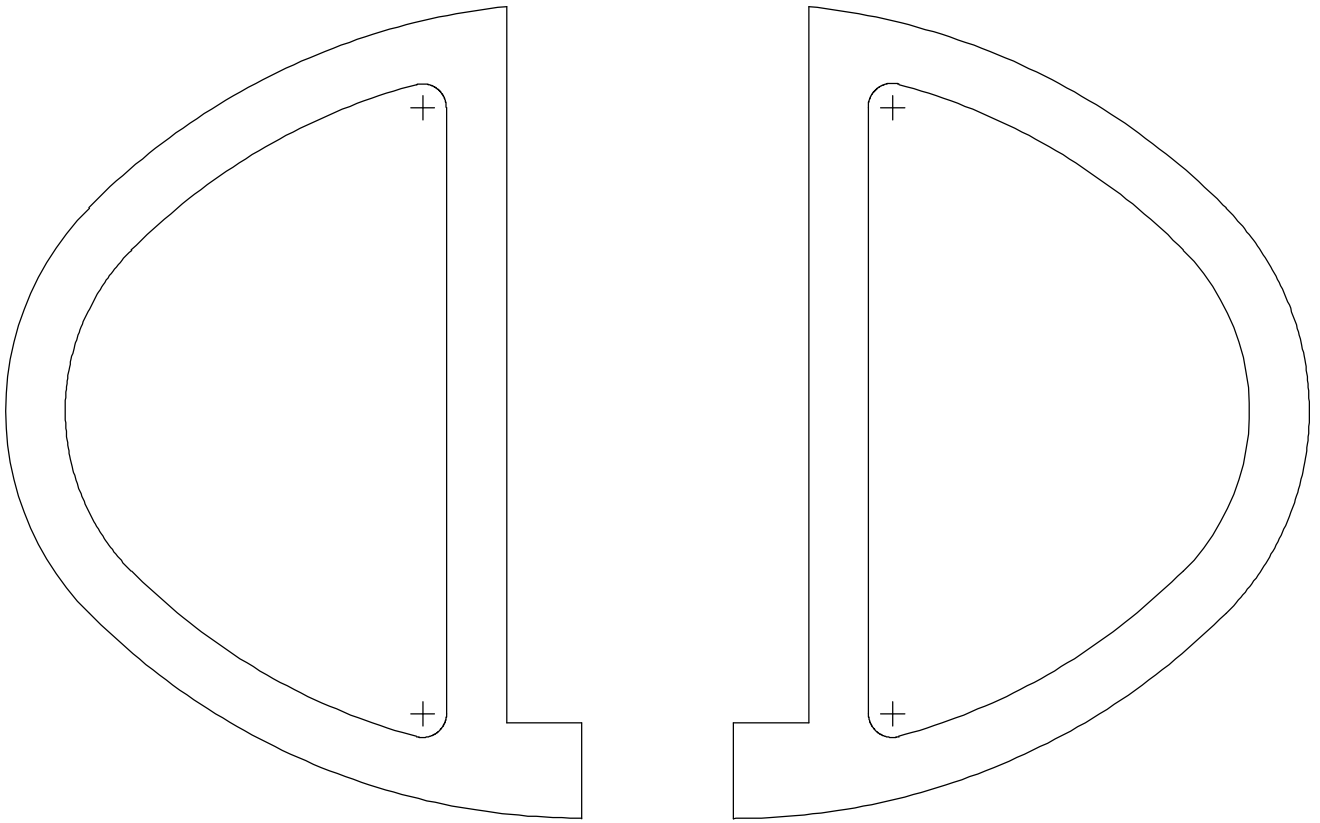

**CUTTING PATTERNS
WC5-12-04-01**

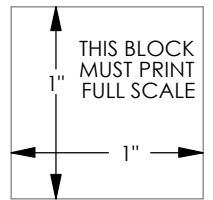

© 2005 Randle Design, LLC
All rights reserved

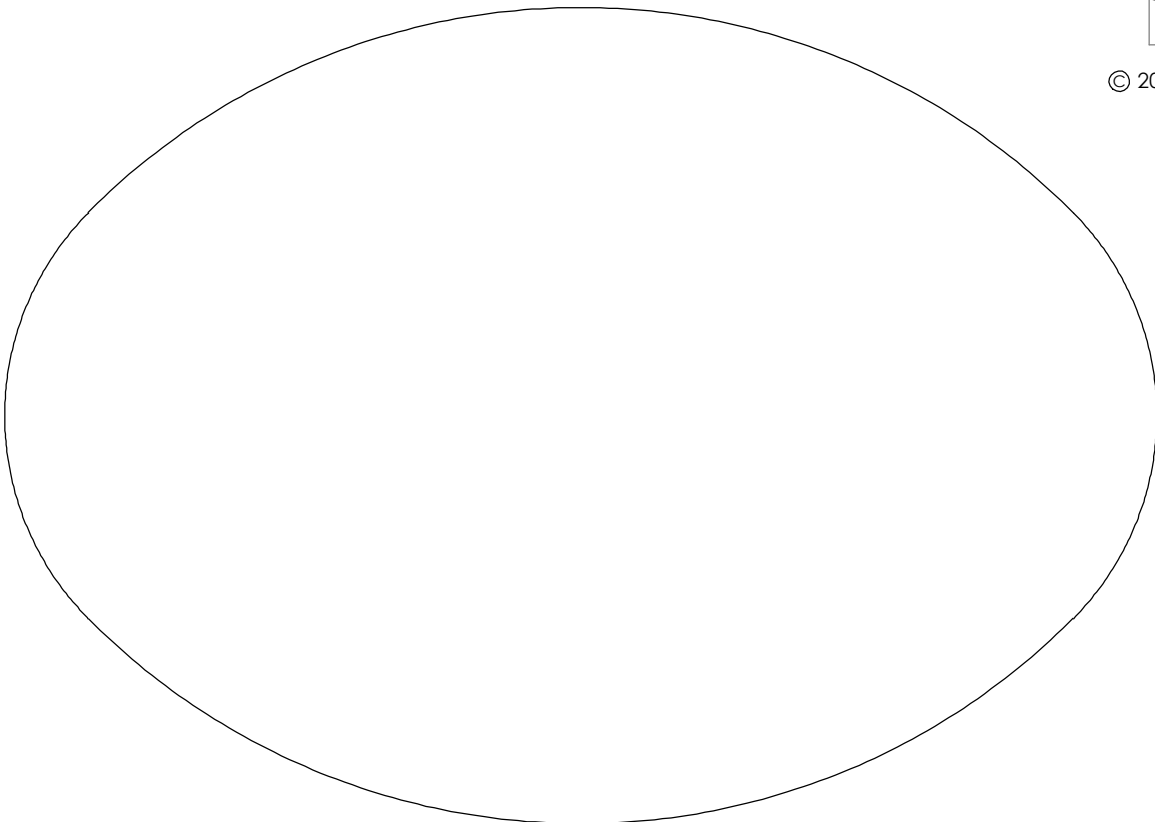

**CUTTING PATTERN
WC5-12-04-02**

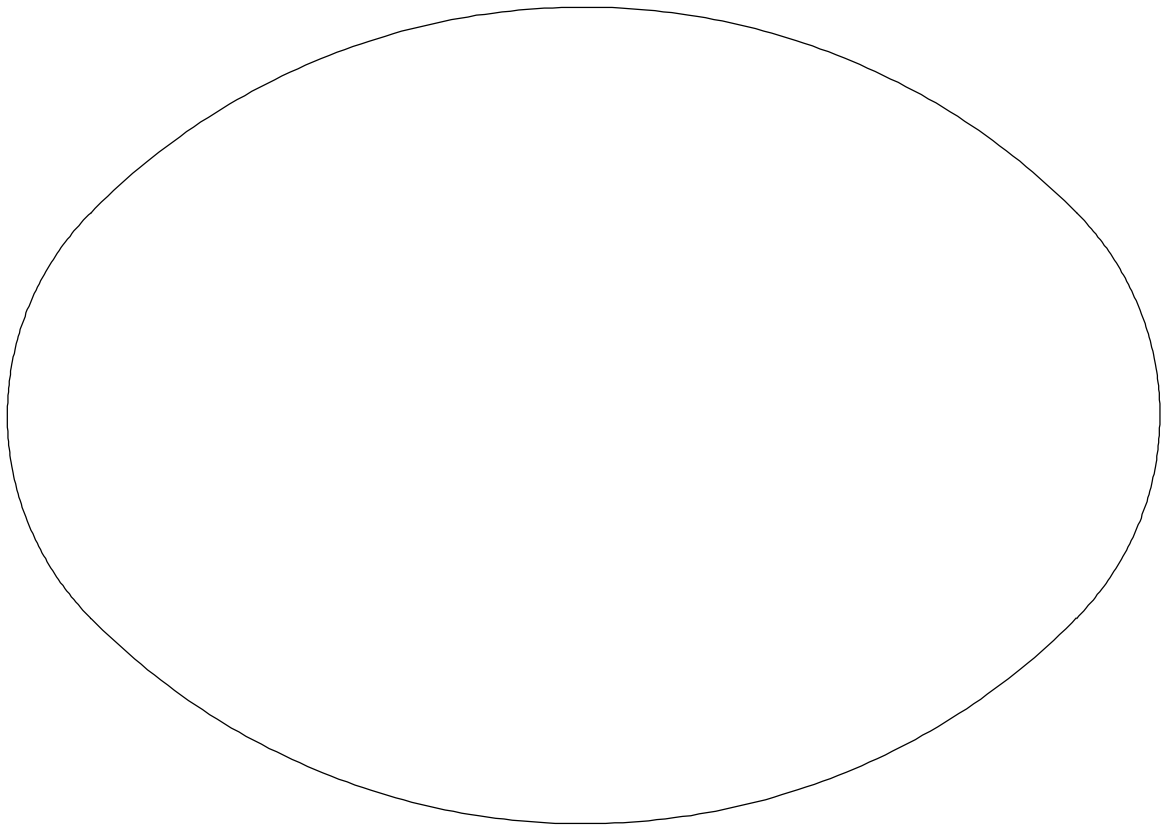

**CUTTING PATTERN
WC5-12-04-02**

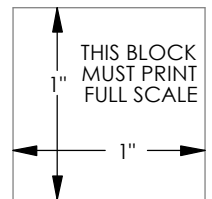
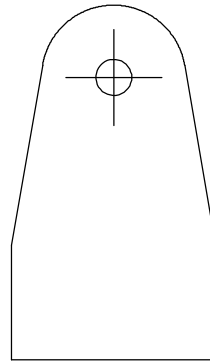
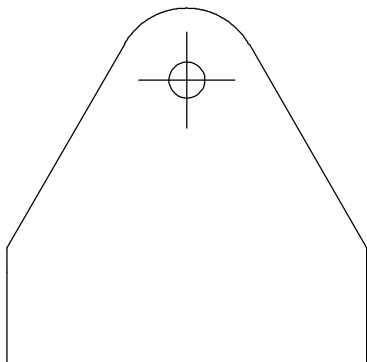
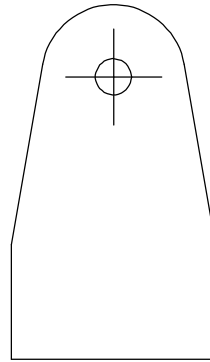
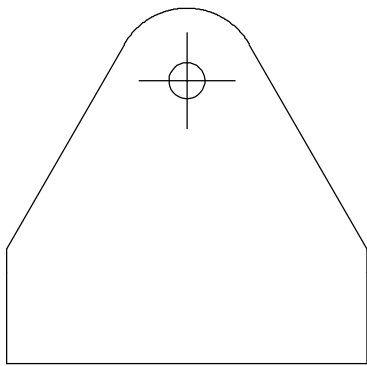

© 2005 Randle Design, LLC
All rights reserved

**CUTTING PATTERNS
WC5-13-01**

**CUTTING PATTERNS
WC5-14-01**