

Through mortise and tenon joint

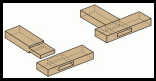

Corner through mortise and tenon joint

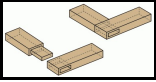

Blind mortise and tenon joint

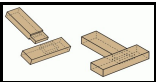

Corner blind mortise and tenon joint

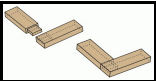

Angled haunched mortise and tenon joint

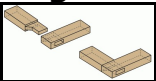

Angled haunched barefaced mortise and tenon joint

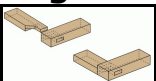

Application of haunched tenon joint to door frame

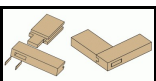
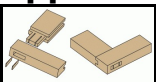

End wedged through tenon and mortise joint



Wedged through tenon and mortise joint

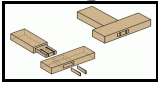

Barefaced blind tenon and mortise joint

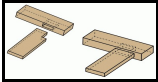

Haunched tenon and mortise joint

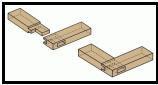

Interlocking tenon and mortise joint for seat rails of chair to leg

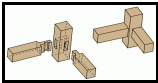

Long and short shouldered tenon and mortise joint

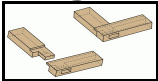

Loose tenon and mortise joint

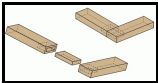

Open through tenon and mortise joint - Bridle joint

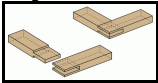

Round tenon and mortise joint

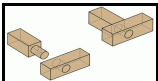

Tenon and mortise joint with mitered face

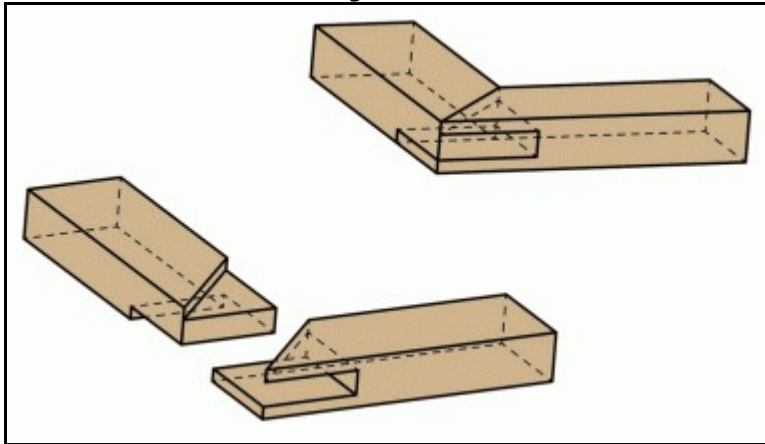

Tusk tenon and mortise joint

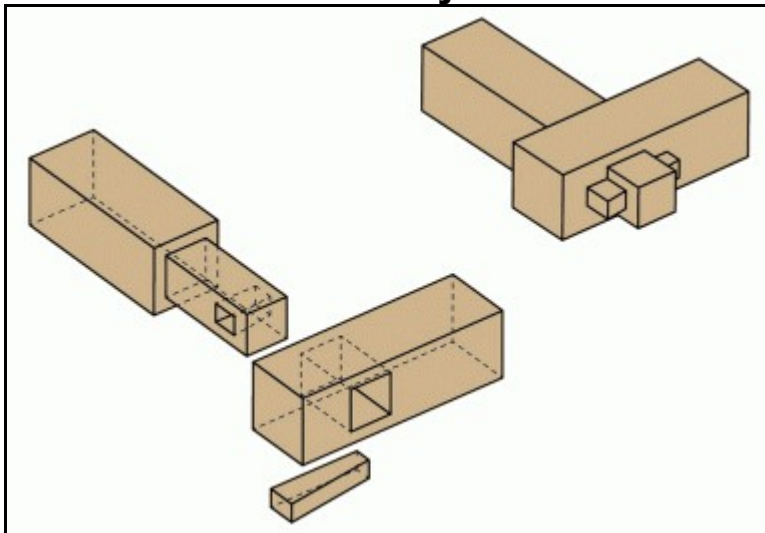

Twin tenon and mortise joint

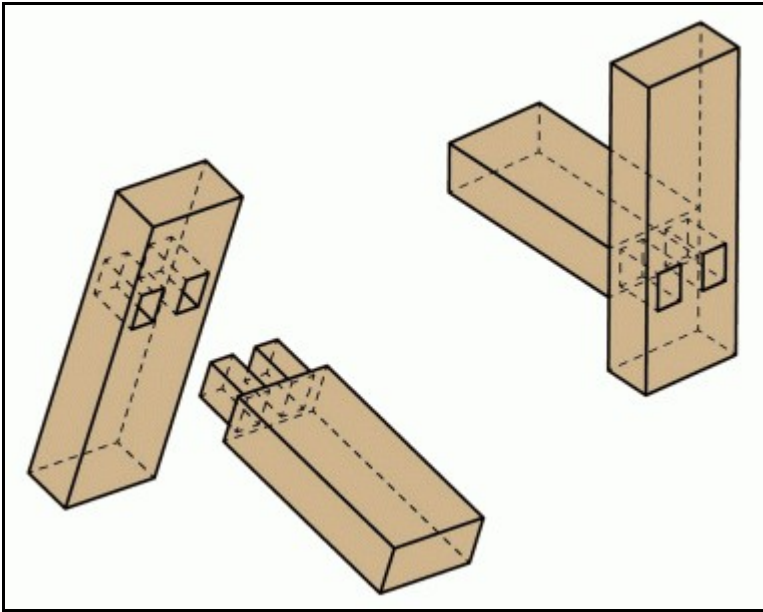

Twin tenon and mortise joint for thick timber

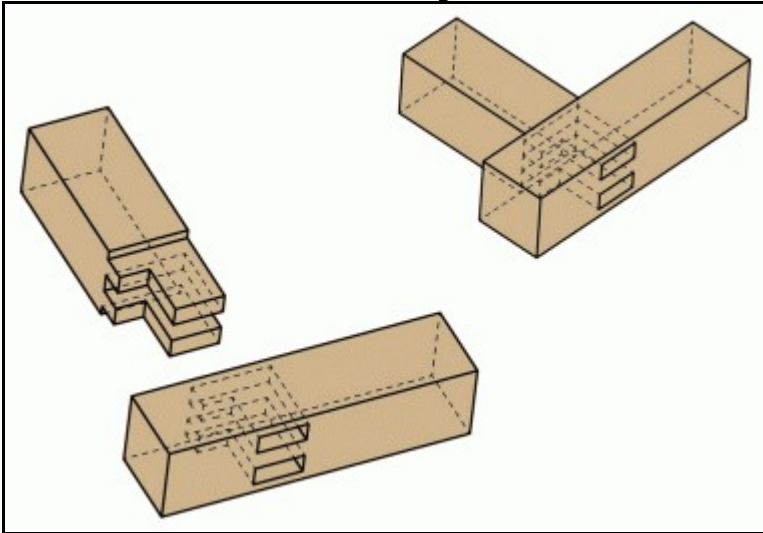

Tenon and mortise joint reinforced with dowel

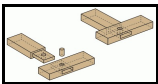

Tenon and mortise joint for fencing

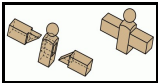

Skewed tenon and mortise joint

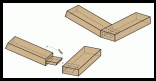

Self wedging tenon and mortise joint

